

SI2302

20V N-Channel Enhancement Mode MOSFET

VDS= 20V

RDS(ON), Vgs@ 4.5V, Ids@ 3A <45mΩ

RDS(ON), Vgs@ 2.5V, Ids@ 2.5A < 59mΩ

Features

Advanced trench process technology

High Density Cell Design For Ultra Low On-Resistance

Package Dimensions

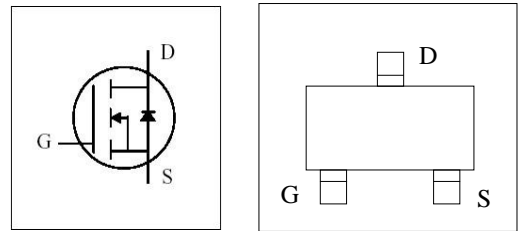
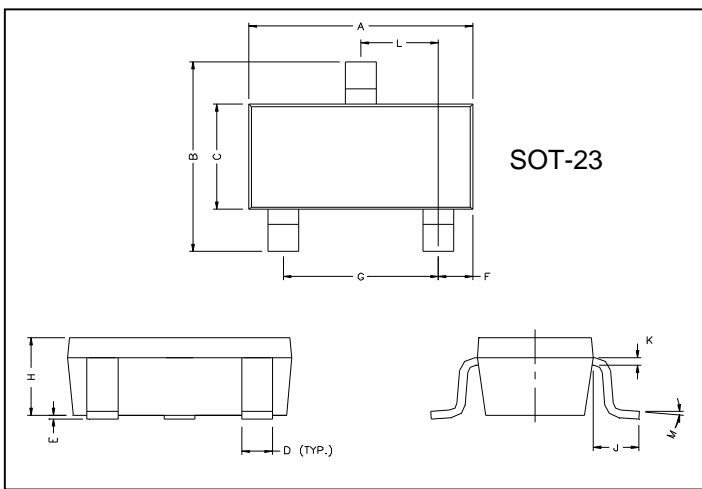

REF.	Millimeter		REF.	Millimeter	
	Min.	Max.		Min.	Max.
A	2.80	3.00	G	1.80	2.00
B	2.30	2.50	H	0.90	1.1
C	1.20	1.40	K	0.10	0.20
D	0.30	0.50	J	0.35	0.70
E	0	0.10	L	0.92	0.98
F	0.45	0.55	M	0°	10°

Maximum Ratings and Thermal Characteristics (TA = 25°C unless otherwise noted)

Parameter	Symbol	Limit	Unit	
Drain-Source Voltage	V _{DS}	20	V	
Gate-Source Voltage	V _{GS}	±10		
Continuous Drain Current	I _D	3	A	
Pulsed Drain Current ¹⁾	I _{DM}	12		
Maximum Power Dissipation ²⁾	P _D	TA = 25°	1.25	W
		TA = 75°C	0.8	
Operating Junction and Storage Temperature Range	T _J , T _{stg}	-55 to 150	°C	
Junction-to-Ambient Thermal Resistance (PCB mounted) ²⁾	R _{thJA}	100	°C/W	
Junction-to-Ambient Thermal Resistance (PCB mounted) ³⁾		166		

Notes

- 1) Pulse width limited by maximum junction temperature.
- 2) Surface Mounted on FR4 Board, t ≤ 5 sec.
- 3) Surface Mounted on FR4 Board.

ELECTRICAL CHARACTERISTICS

Parameter	Symbol	Test Condition	Min.	Typ.	Max.	Unit
Static						
Drain-Source Breakdown Voltage	BV_{DSS}	$V_{GS} = 0V, I_D = 250\mu A$	20			V
Drain-Source On-State Resistance ¹⁾	$R_{DS(on)}$	$V_{GS} = 4.5V, I_D = 3A$		30	45	m Ω
		$V_{GS} = 2.5V, I_D = 2.5A$		37	59	
Gate Threshold Voltage	$V_{GS(th)}$	$V_{DS} = V_{GS}, I_D = 250\mu A$	0.45		1.5	V
Zero Gate Voltage Drain Current 0	I_{DSS}	$V_{DS} = 16V, V_{GS} = 0V$		1		uA
		$V_{DS} = 16V, V_{GS} = 0V, T_J = 55^\circ C$			10	
Gate Body Leakage	I_{GSS}	$V_{GS} = \pm 10V, V_{DS} = 0V$			± 100	nA
Forward Transconductance ¹⁾	g_{fs}	$V_{DS} = 5V, I_D = 3A$		10	—	S
Dynamic						
Total Gate Charge	Q_g	$V_{DS} = 10V, I_D = 3A$ $V_{GS} = 4.5V$		5.4		nC
Gate-Source Charge	Q_{gs}			0.65		
Gate-Drain Charge	Q_{gd}			1.6		
Turn-On Delay Time	$t_{d(on)}$	$V_{DD} = 10V, R_L = 5.5\Omega$ $I_D \cong 3A, V_{GEN} = 4.5V$ $R_G = 6\Omega$		12		ns
Turn-On Rise Time	t_r			36		
Turn-Off Delay Time	$t_{d(off)}$			34		
Turn-Off Fall Time	t_f			10		
Input Capacitance	C_{iss}	$V_{DS} = 10V, V_{GS} = 0V$ $f = 1.0\text{ MHz}$		340		pF
Output Capacitance	C_{oss}			115		
Reverse Transfer Capacitance	C_{rss}			33		
Source-Drain Diode						
Max. Diode Forward Current	I_S				1.6	A
Diode Forward Voltage	V_{SD}	$I_S = 1.0A, V_{GS} = 0V$			1.2	V

¹⁾ Pulse test: pulse width $\leq 300\mu s$, duty cycle $\leq 2\%$

Typical Electrical and Thermal Characteristics

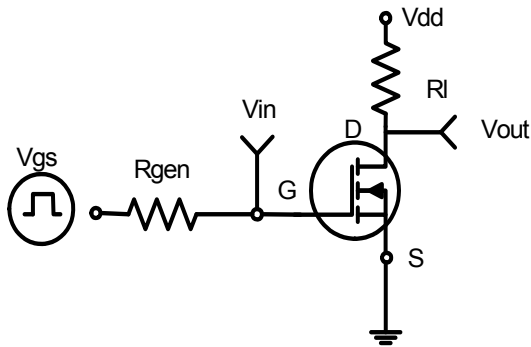

Figure 1: Switching Test Circuit

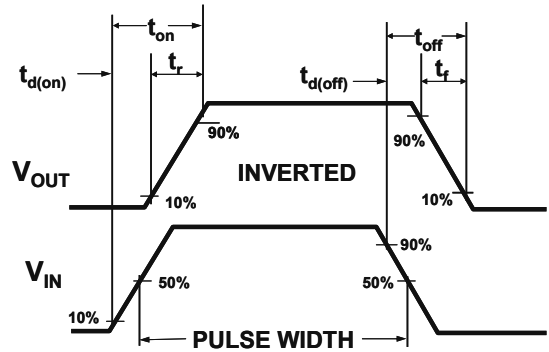

Figure 2: Switching Waveforms

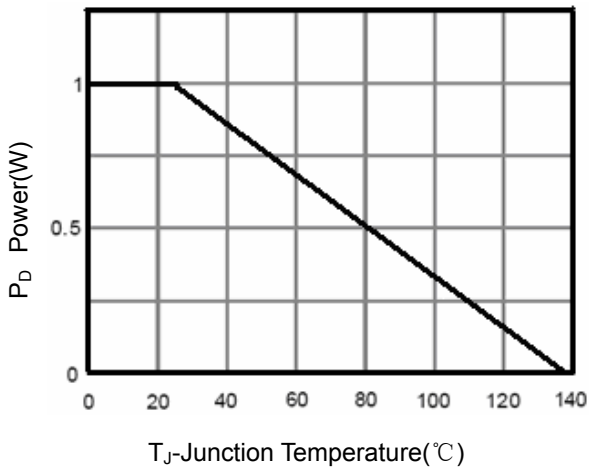

Figure 3 Power Dissipation

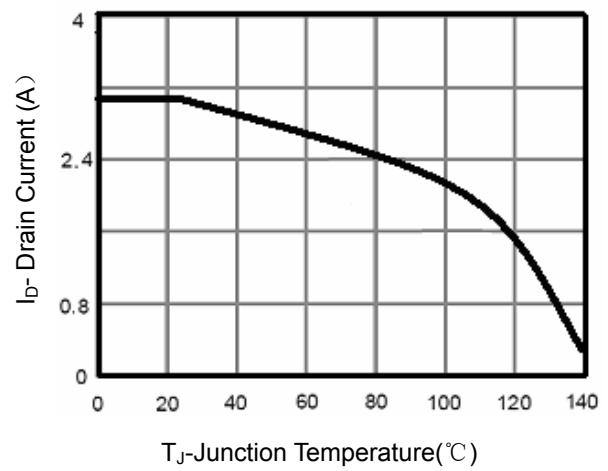

Figure 4 Drain Current

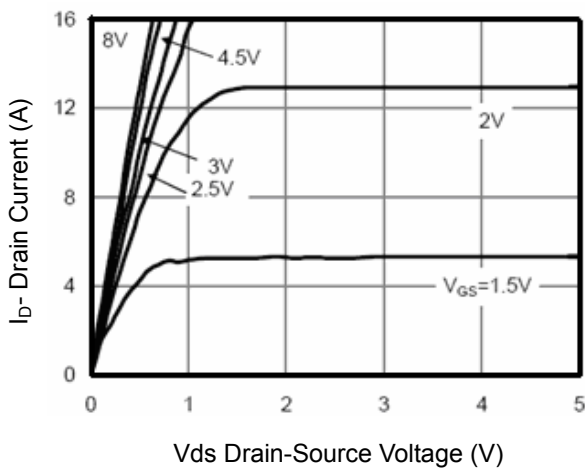

Figure 5 Output Characteristics

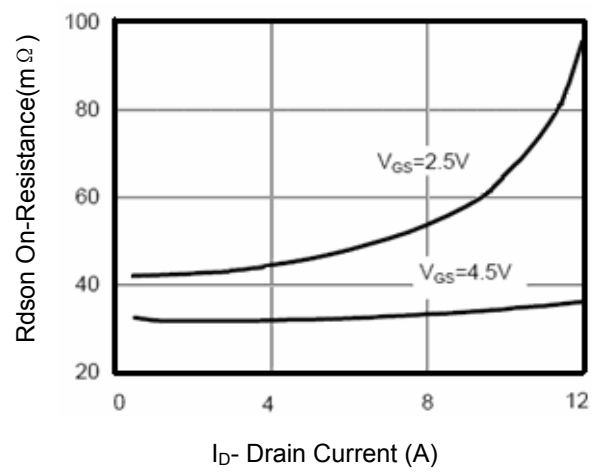

Figure 6 Drain-Source On-Resistance

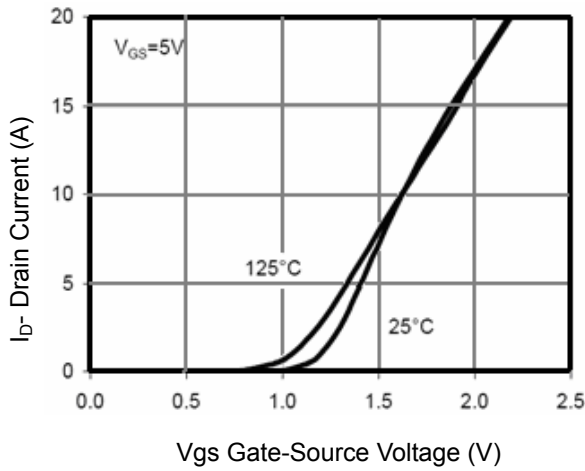

Figure 7 Transfer Characteristics

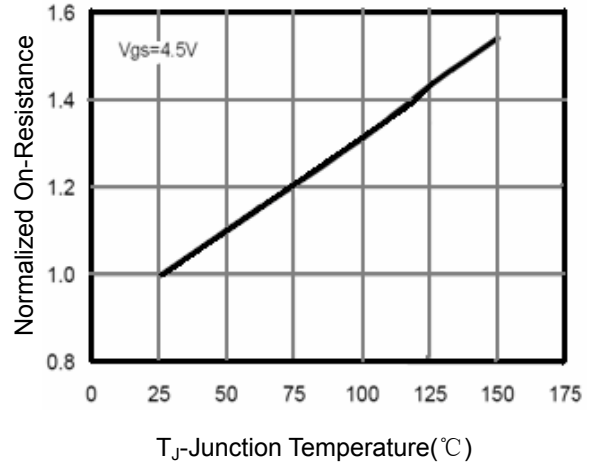

Figure 8 Drain-Source On-Resistance

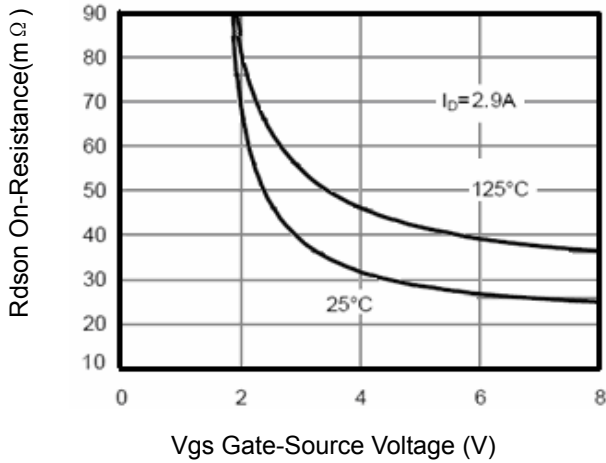

Figure 9 Rds(on) vs Vgs

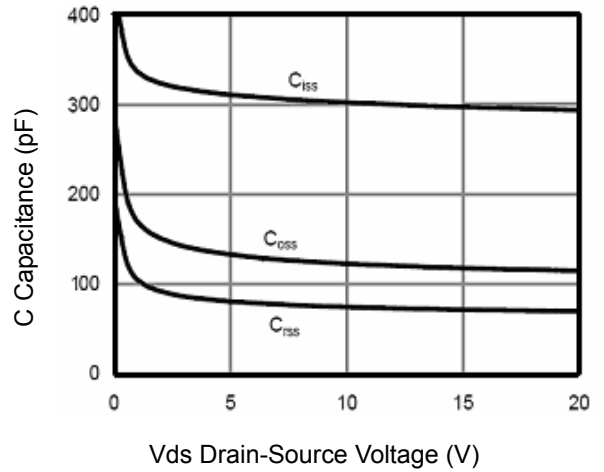

Figure 10 Capacitance vs Vds

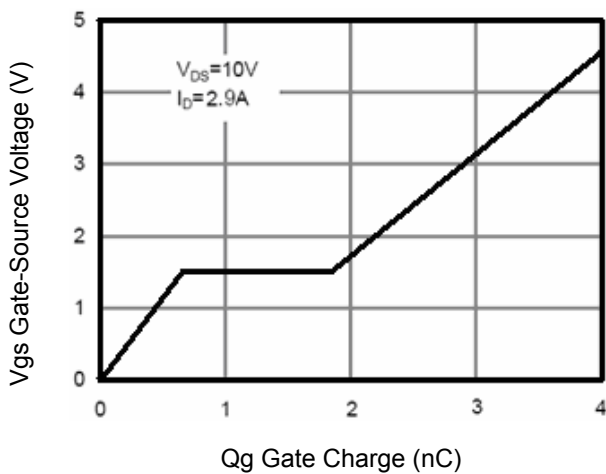

Figure 11 Gate Charge

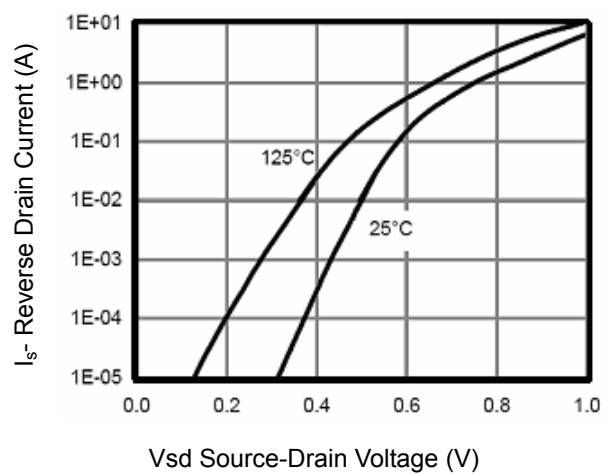

Figure 12 Source- Drain Diode Forward

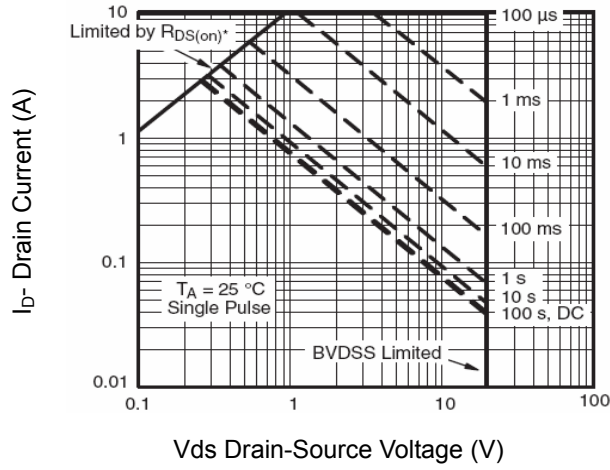

Figure 13 Safe Operation Area

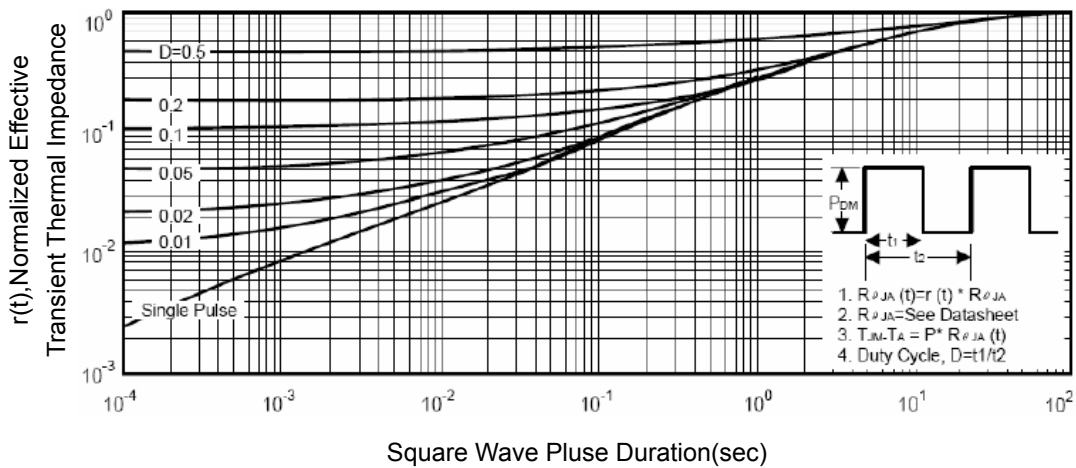

Figure 14 Normalized Maximum Transient Thermal Impedance